



**MagVISE EEPM**  
**Electro-Permanent Chuck and Controller**  
**EEPM 480V Series**

Dear Customer,

Congratulations on your purchase of an MagVISE EEPM Electro-Permanent Magnetic Chuck. With proper installation, operation, and maintenance, your EEPM Magnetic Chuck will deliver years of reliable performance.

Please review the contents of this Operations Manual thoroughly and familiarize yourself with the proper installation, operation, and maintenance procedures that ensure the long-term reliability and performance of your EEPM Magnetic Chuck.

We're here to help! If you have any questions about the installation, operation, or maintenance of your EEPM Magnetic Chuck please contact customer service at: 877-354-3837 or [info@earthchain.com](mailto:info@earthchain.com). We are committed to your complete satisfaction with our products and service.

Thank you for your business.

Earth-Chain  
9930 E. 56th St.,  
Indianapolis, IN 46256



# TABLE OF CONTENTS

<b>UNPACKING YOUR MAGVISE EEPM CHUCK AND CONTROLLER</b> .....	page 4
<b>MAGVISE EEPM CHUCK INSTALLATION</b> .....	page 4
Factors That Affect Magnetic Holding Power.....	page 4
<b>MAGVISE EEPM CONTROLLER INSTALLATION</b> .....	page 5
Power Supply Check Procedure.....	page 5
Chuck Controller Electrical Connections.....	page 5
<b>MAGVISE EEPM CONTROLLER-TO-CHUCK CONNECTIONS</b> .....	page 5
Interfacing With a CNC Machine Control.....	page 6
<b>MAGVISE EEPM CONTROLLER AND CHUCK OPERATION</b> .....	page 6
CAUTIONS AND WARNINGS .....	page 7
Powering Up The Controller .....	page 7
Demagnetizing The Chuck.....	page 7
Magnetizing The Chuck .....	page 8
Adjusting the Magnetic Holding Power .....	page 8
Powering Down the Controller and Chuck .....	page 9
<b>PART SETUP</b> .....	page 9
<b>MAINTENANCE</b> .....	page 10
SAFETY PRECAUTIONS.....	page 10
Chuck Controller Maintenance .....	page 10
Magnetic Chuck Maintenance .....	page 11
Induction Block Maintenance .....	page 11
<b>STORING THE EQUIPMENT</b> .....	page 12
<b>DISPOSING OF THE EQUIPMENT</b> .....	page 12
<b>TROUBLESHOOTING</b> .....	page 13
<b>APPLICATION EXAMPLES</b> .....	back cover

## Unpacking the Chuck and Controller

The following items were shipped with your order:

- ✓ 1 EEPM magnetic chuck
- ✓ 1 chuck controller with attached power supply cable for the chuck
- ✓ 1 auxiliary hand-held remote control
- ✓ 1 set of 4 toe clamps, and this Operations Manual

Upon receiving the equipment carefully unpack the crate and verify:

- ✓ The packing list describes the correct products ordered
- ✓ All items listed on the packing list arrived intact and undamaged

In the event of damages please contact Earth-Chain immediately at 877-354-3837 or [info@earthchain.com](mailto:info@earthchain.com).

## MagVISE EEPM Chuck Installation

Read this manual completely before installing the chuck and controller. Always obey the **CAUTIONS AND WARNINGS** instructions in this manual. Installation should only be carried out by qualified personnel.

1. Make sure all the EEPM components and your machine bed are clean and dry.
2. Use an Earth Chain EZ-Lift Lifting Magnet to safely transport the chuck to your machine bed.
3. Position the magnetic chuck in the desired location on the bed of your machining center or pallet. Secure the chuck using the supplied toe clamps.
4. Verify that the chuck is properly secured by tapping it on the side with a rubber hammer, or holding a block of wood against the side of the chuck and striking it with a regular hammer.

## Factors That Affect Magnetic Holding Power

- Higher carbon content in the workpiece reduces the magnetic attraction between the chuck and the workpiece
- Thickness of workpiece
  - a) above 1-1/4" = 100%
  - b) 3/4" – 1-1/4" = 85%
  - c) 3/8" – 3/4" = 50%
- Contact surface between workpiece and chuck. Chips, burrs, oil, dirt, rough or uneven surfaces will reduce holding power
- Contact area with the chuck. Holding power is approximately 1 ton for every 4 poles
- Temperatures above 176° will reduce holding power

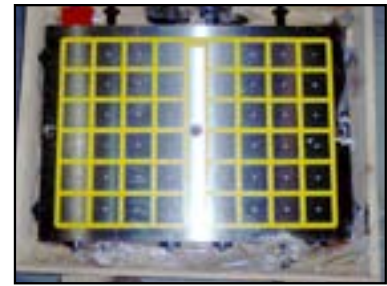

## Specifications

### Chuck Type:

Electro-Permanent Magnetic

### Pole Pattern:

Square Pole (50mm x 50mm)

### Power Requirements:

440-480V/30A single phase



transporting the EEPM chuck



securing EEPM chuck to bed "T" slots



toe clamps

# MagVISE EEPM Controller Installation

We recommend having a certified electrician make all electrical connections and complete the **Power Supply Check** (below) to ensure proper power supply and wiring connections.

## Power Supply Check Procedure

The EEPM chuck and controller **MUST** have the correct power supply to operate safely. Have a certified electrician test and verify that your power supply meets the power requirements listed below. Write the actual readings in the spaces below, and fix any problems before attempting to install and operate your EEPM chuck.

POWER REQUIREMENTS	ON-SITE ACTUAL
Voltage at outlet: 480V	
Amperage: 30A circuit	
Phase: single phase	
Hertz (Hz): 60	
10 gage wire from breaker box to outlet	
Dedicated circuit	



## CAUTION

- Connecting a power supply that does not meet the requirements may cause unsatisfactory performance, damage or injury, and may void the warranty.

## Electrical Connections

The chuck controller requires 440-480V/30A single phase power. For the single phase input, the cable has three leads.

- Connect the wires as shown in the connection diagram (right). 2 cable leads are provided for phase and neutral, and one for the ground.
- For your convenience we have installed a **NEMA L8-30P** plug on the chuck controller power cord. You will need to provide a **NEMA L8-30R** receptacle. A drawing of the NEMA L8-30R is shown (bottom right).

## MagVISE Controller-to-Chuck Connections

Place the chuck controller next to the CNC machine's control panel in a location away from chips, oil, coolant, and any moving parts of the machine, but near enough to the machine bed and EEPM chuck for convenient operation.

NOTES

---

---

---

---

---

---

---

---

---

---

---

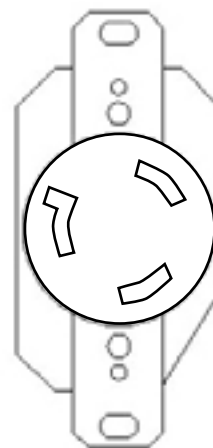
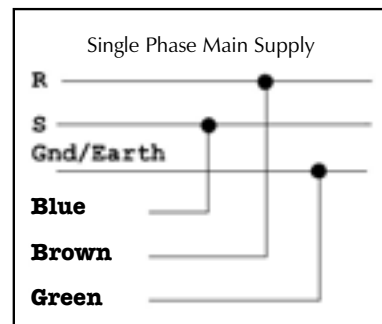

NEMA L8-30R

1. Connect the chuck controller power cable to the correct power source (440-480V/30A single phase)
2. Connect the hand-held remote cable to the 15 pin connection on the right-side of the chuck controller. The hand-held remote control has a magnetic back so it can be attached to the CNC machine or control if desired.
3. Remove the cap from the EEPM chuck power receptacle and gently spray the socket and cap with dry shop air to knock out any unseen contaminants. Inspect the electrical connection on the front of the chuck for any contaminants or damage. Connect the power supply cable from the controller to the power receptacle on the chuck. Make sure it is properly secured.

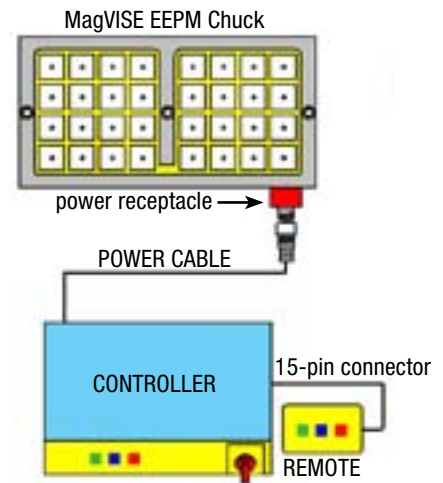

## Interfacing With a CNC Machine Control

The MagVISE EEPM magnetic chuck controller can interface with most CNC controls via the 9-pin connection on the back of the controller, allowing the magnetic chuck to be operated from the CNC control panel.

The magnetic status of the EEPM chuck (demagnetized or magnetized) is indicated with a set of dry contacts connected to pins 5, 7, & 9 of the CNC control connector. When the contacts close between 5 & 9, the chuck status is “demagnetized.” When the same contacts are open, the chuck status is “magnetized.”

The contacts between 7 & 9 operate in reverse of 5 & 9. To magnetize the chuck, connect the negative of an external 5-26 VDC supply to Pin 1 and connect the positive 5-26 VDC to Pin 3 for 0.8 to 1.5 seconds. To demagnetize the chuck, connect the negative of an external 5-26 VDC supply to Pin 1 and connect the positive 5-26 VDC to Pin 2 for 0.8 to 1.5 seconds.

### The pin assignments are as follows:

- Pin 1 – Status Relay COM
- Pin 2 – Status Relay N.O. Chuck is magnetized
- Pin 3 – Status Relay N.C. Chuck is demagnetized
- Pin 5 – Demagnetize command
- Pin 7 – Magnetize Command
- Pin 9 – Command Negative (0V)

## MagVISE Chuck and Controller Operation

Your EEPM chuck is designed to work best with iron-bearing metals (ferrous) including all grades of steel and cast iron. Maximum holding power requires stock of sufficient thickness and material type to create a magnetic attraction, a power supply that meets the requirements, and smooth clean contact between the magnetic chuck and the workpiece. Your results will vary depending upon the size, shape, thickness and material type you are holding.



chuck electrical receptacle



Once put in a magnetized state, the EEPM chuck maintains constant holding power until it is put in a demagnetized state. Electricity is **NOT** required to maintain magnetic holding power. Electricity is used only to reverse the polarity of the alnico magnets, thereby changing the magnetic state of the chuck. The chuck will **NOT** lose holding power in the event of a power loss. There is no decay of magnetic holding power over time, and there is no heat generated by the chuck.

## Powering Up the Controller



### CAUTIONS AND WARNINGS

- *To prevent injury never put any part of your body (i.e. fingers, skin, etc) between a metal object and the chuck surface. Do not wear rings, watches, necklaces, bracelets etc., while operating the chuck.*
  - *To prevent damage to the chuck and/or controller wait at least two (2) minutes after magnetizing or demagnetizing the chuck, before attempting to change the magnetic state of the chuck again.*
  - *Always make sure the power receptacle on the chuck and the plug on the chuck controller cable are free of moisture, chips, and any contaminants before connecting the chuck controller cable to the chuck. Failure to do so could result in damage to the chuck and chuck controller.*
  - *Always verify that the controller is properly connected to the chuck before operating the controls.*
  - *Always replace the cap on the chuck power receptacle when disconnecting the power cable from the chuck.*
  - *Always use workstops when operating the chuck at a power level lower than 8 to ensure the workpiece does not move during machining.*
  - *High temperatures (176° or above) will cause permanent decay / loss of magnetic power. Do not operate the chuck under high temperature conditions.*
1. Turn the main power switch on the chuck controller to “On”
  2. Verify that the controller and the hand-held remote are getting power by visually checking the small red lights in both LED displays for illumination.

## Demagnetizing the Chuck

1. Press the blue and the red buttons on the chuck controller (or hand-held remote) simultaneously for 1 second and release.
2. Check that the red light above the red button on the chuck

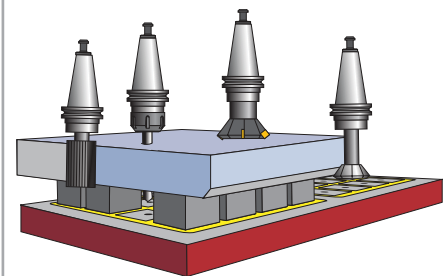
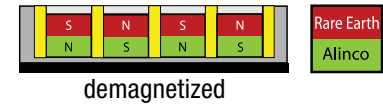
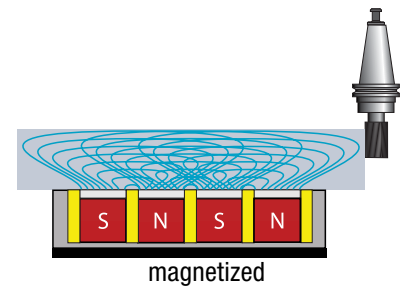

magnetic workholding allows machining on 5 sides & thru-hole drilling



controller and hand-held remote

controller (or hand-held remote) is lit. This indicates the chuck is demagnetized (OFF).

3. Verify that the chuck is demagnetized by touching the surface of the chuck (**touch test**) with a ferrous object (ex. screwdriver). **Be careful not to put any part of your body between the ferrous object and the surface of the workpiece.** You should not feel any magnetic attraction as the tip of the screwdriver comes in close proximity to the chuck surface.

## Magnetizing The Chuck

1. Verify that the chuck is demagnetized by following the procedure on pages 7 and 8. **Wait two minutes before proceeding to step 2.**
2. Set the power level as desired using the + or - keys. We recommend using level 8 for general operation.
3. Press both the blue and green buttons on the chuck controller (or hand-held remote) simultaneously for 1 second and release.
4. Check that the green light above the green button on the chuck controller (or hand-held remote) is lit. This indicates the chuck is magnetized (ON).
5. Verify that the chuck is magnetized by performing a **touch test** (see step 3 at top of page). You should feel a pull as the tip of the screwdriver comes in close proximity to the chuck surface.

## Adjusting The Magnetic Holding Power

The controller has 8 power levels. Level 1 is the weakest, and 8 is strongest. We recommend using level 8 for general operation. Using the control panel or hand-held remote, you can adjust magnetic power levels to compensate for stock thickness or to provide better chip evacuation.

You only need to adjust the holding power if a strong magnetic field extends beyond the surface of the workpiece. This is more likely when workpieces are under  $\frac{3}{4}$ " thick. Perform a **touch test** (see step 3 at top of page) to determine if it is necessary to reduce the magnetic power.

1. **Power Up** and **Demagnetize** the EEPM chuck following the procedures and **CAUTIONS AND WARNINGS** from page 7 and 8. **Wait two minutes before proceeding to step 2.**
2. Adjust the power level as needed using the + or - keys. **Magnetize** the chuck and verify that it is magnetized by following the procedures and **CAUTIONS AND WARNINGS** from page 7 and 8.
3. Perform the **touch test** (see step 3 at top of page) to verify that the magnetic field is no longer strong at the surface of the workpiece.
4. Repeat steps 1, 2, and 3 if necessary.



transporting workpiece



thru-hole application using fixed induction blocks



use the + and - buttons to increase or decrease the magnetic power setting



## Powering Down the EEPM Controller and Chuck

1. **Demagnetize** the EEPM chuck and verify that it is demagnetized by following the procedures and **CAUTIONS AND WARNINGS** from page 7 and 8. **Wait two minutes before proceeding to step 2.**
2. Turn **OFF** the power switch on the chuck controller.
3. Disconnect the power cable from the chuck and gently blow out the receptacle with dry shop air to remove any contaminants. Replace the power receptacle cap making sure it is properly secured.

## PART SETUP



### CAUTION

- *Never place your hand or any body part between the magnetic chuck surface and a metal object.*
1. **Power Up** and **Demagnetize** the EEPM chuck following the procedures and **CAUTIONS AND WARNINGS** from page 7 and 8. **Wait two minutes before proceeding to step 2.**
  2. If you are using fixed or spring-loaded induction blocks install these on the chuck before loading your workpiece. Then, machine flat the top surface of the fixed induction blocks only.
  3. Center your workpiece on the chuck. Position it so it covers an even number of poles (4, 8, etc.) as evenly as possible.
  4. Install workstops as needed. Small or thin workpieces may require workstops to prevent the part from moving during machining. For best results we recommend using workstops whenever possible. Examples of work-stops are fixed pole induction blocks, dowel pins, or the side stops included with the magnetic chuck. Also, subplates and fixed-pole induction blocks can be machined to “nest” parts and provide a positive stop.
  5. Adjust the power level as needed using the + or - keys. We recommend using power level 8 for standard operation. **Magnetize** the chuck and verify that it is magnetized by following the procedures and **CAUTIONS AND WARNINGS** from page 7 and 8.
  6. Perform a **touch test** (see step 3, pg. 8) to verify that the magnetic field is no longer strong at the surface of the workpiece. If a strong magnetic field is present on the top of the workpiece adjust the power level as necessary following the procedures on pages 7 and 8.
  8. Verify that the workpiece is properly secured by gently tapping it on the side with a soft hammer, or striking a block of wood with a regular hammer while checking for any movement.
  - 9 After the machining is complete, **Demagnetize** the EEPM chuck following the procedures and **CAUTIONS AND WARNINGS** from page 7 and 8. You may now remove the workpiece.

## INDUCTION BLOCKS

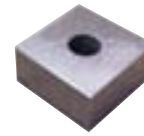

EEPM-S50



EEPM-SP50



EEPM-SPF50



EEPM-SPF50-STOP

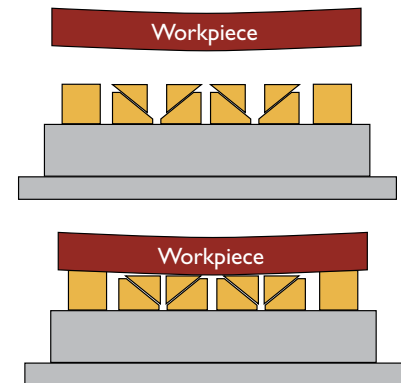

use fixed induction blocks on the corners and spring-loaded induction blocks in the centers to create a setup designed to hold warped stock (see below)



## MAINTENANCE

Proper maintenance increases the life expectancy of your chuck and controller and keeps them in safe working condition.



### SAFETY PRECAUTIONS

Follow these precautions while servicing the chuck and/or controller:

- *Only qualified personnel should carry out maintenance operations*
- *Always make sure the receptacle on the chuck and the plug on the chuck controller cable are free of moisture, chips, and any contaminants before connecting the chuck controller cable to the chuck. Failure to do so could result in damage to the chuck and chuck controller.*
- *Always replace the cap on the chuck power receptacle when disconnecting the power cable from the chuck*
- *Disconnect the equipment from the power supply before attempting any repairs or maintenance. Never touch connections or components unless the power supply is disconnected*
- *Do not wear rings, watches, necklaces, bracelets etc. while performing maintenance operations*
- *Always use protective gloves, safety shoes, and any other protective gear needed*

### Chuck Controller Maintenance

Regular routine maintenance includes keeping the exterior of the controller, hand-held remote, and cables clean and dry. Every time you use the chuck make the following inspections.

1. Carefully inspect all electric connections and condition of the cables between the chuck and controller, and the hand-held remote too. Make sure that no part of the power supply circuit or connections has become loose or show signs of overheating.
2. Make sure all cycle lamps are functioning well and the keypad covers are all in good shape.

## WORKSTOPS



workstops on side of chuck



DETAIL: workstop included with EEPM-SPF50-STOP induction block



part nests machined into a subplate provide workstops for repeat jobs.



## Magnetic Chuck Maintenance

There are no user-serviceable parts inside the chuck, so chuck maintenance is limited to maintaining the surface finish of the chuck face and verifying that the electrical connection is clean and uncontaminated by chips or liquid.

## Weekly Maintenance

For proper operation the chuck surface must be clean and smooth. Regularly check the surface condition of all magnetic poles making sure they are not damaged. Remove any gouges or roughness using 250 grit sandpaper with a backing block. Finish the surface using 400 grit. Remove any rust or scale deposits with 400 grit sandpaper and a backing block. Remove all dust or other contaminants before storing the chuck or returning it to operation.

## Daily Maintenance

Unscrew the cap and inspect the electrical socket connection on the front of the chuck. Make sure there are no chips or other contaminants in the socket. Gently spray the socket and cap with dry shop air to knock out any unseen contaminants. Make sure the socket and cap are clean and dry, and the cap functions properly and makes a tight seal. Any contaminants or liquid in the socket may cause damage during magnetize / demagnetize operations.

## Induction Block Maintenance

1. The amount of holding power provided from the chuck is greatly influenced by the contact area between the chuck (or induction blocks) and the workpiece. Regularly check the condition of all induction blocks and remove any gouges, rust, or other signs of wear.
2. Machine the top surface of the inductions blocks as needed to restore them to a smooth, even surface.

## SUBPLATES

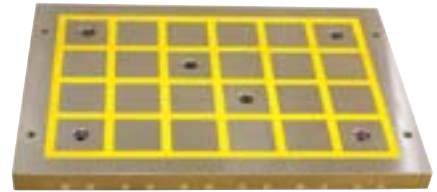

subplates are sized to fit your chuck



part nesting in a subplate



## Storing The Equipment

If the need arises to store the equipment for a certain amount of time observe the following instructions.

- ✓ *Demagnetize the chuck (follow the procedures on pages 7 and 8)*
- ✓ *Turn the power switch on the chuck controller to "OFF"*
- ✓ *Disconnect the chuck controller from the power supply*
- ✓ *Disconnect the controller from the chuck*
- ✓ *Remove any moisture or debris from the chuck receptacle and replace the cap over the receptacle*
- ✓ *Clean all components and coat the surface of the chuck in a protective, rust inhibitive solvent.*
- ✓ *Cover the equipment with a waterproof sheet (plastic)*
- ✓ *Keep the equipment in a dry environment. To preserve all electric parts the room temperature must be between 45°F to 80°F*

## Disposing of the Equipment

If the need arises to dispose of the equipment, it is mandatory to observe a few fundamental rules for the safeguarding of the environment.

- ✓ *Protective covering, flexible pipes, plastic or non-metal material should be dismantled and disposed of separately.*
- ✓ *The electric components should be disassembled and if in good condition, re-used or recycled, or if that is not possible properly disposed of according to local municipal regulations.*
- ✓ *This equipment contains polluting oils that must be disposed of at authorized waste disposal sites.*

## TROUBLE SHOOTING

**Problem:** The controller is **ON** but the lamp in the remote is not lit.

**Solution:** (a) *The power supply cable is loose or is not connected properly.*

**Problem:** The chuck does not magnetize / demagnetize when the correct buttons are pushed.

**Solution:** (a) *The chuck cable is not properly connected to the controller, or the receptacle contains moisture or debris.*

(b) *The power supply does not meet the required specifications, or is incorrectly wired to the controller.*

**Problem:** Insufficient holding power

**Solution:** (a) Verify that the power supply meets the requirements stated in the Power Requirements section of this manual.

(b) Verify that the power setting on the chuck controller is set to the maximum value(8). The power setting must be changed when the chuck is in a demagnetized state.

(c) Verify that both the blue and green buttons on the chuck controller or hand-held remote unit are pressed at the same time for a period of one full second. Do not hold the buttons down for more than 2 seconds.

(d) Verify that the workpiece covers at least 4 poles and is thick enough, and has enough iron content to be magnetically attracted to the chuck.

(e) Verify that the mating surfaces of the chuck and the workpiece are clean, smooth, and free of burrs.

(f) Machine the surface of the fixed pole extensions to ensure a uniform, flat surface.

(g) Remove any oil or coolant from the workpiece and chuck surface before positioning workpiece on chuck.

(h) Install workstops as needed to prevent slippage.

# APPLICATION EXAMPLES

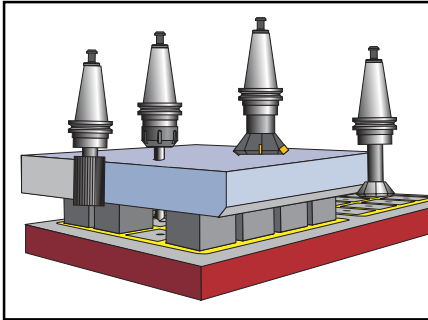

Machine 5 sides freely and thru-hole drill



Face milling warped stock



Works great for machining mold cavities



Flood coolant hole making application



5 axis machining

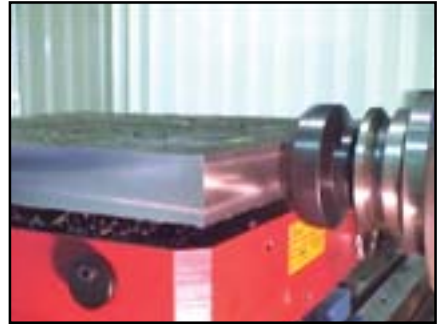

Rotary Table application



Works on thick or thin workpieces



Heavy side loads



Gang setups for high-volume



tombstones for palletized setups



Holding power to take big cuts

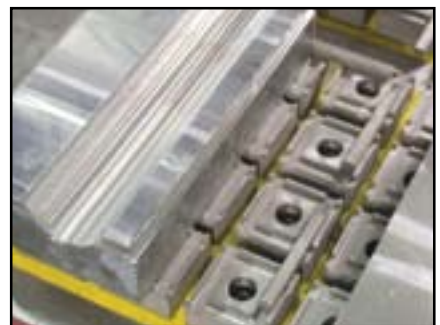

Use induction blocks as work stops

9930 East 56th St., Indianapolis IN 46236 • (877) 354-3837 or (317) 803-8034 for assistance.